



Industrial Microscopes LV150N/LV150NA/LV100ND/LV100NDA

ECLIPSE LV-N

Industrial Microscopes



Together with new optics, ECLIPSE is evolving to the next stage.

Modularized to meet industrial microscope applications in diverse fields of industry, including semiconductor devices, packaging, FPDs, electronic components, materials, and precision molds.

The ECLIPSE LV Series continues to evolve while offering various stand and illumination units selectable according to the observation method and purpose.

Four types – motorized and manual types plus dedicated reflected illumination and combined reflected/transmitted illumination types – are available to meet any application.

Illuminators

Expanded lineup

Added a compact LED illuminator to the existing lineup.
With the use of LED, Nikon illuminators are power saving and achieve long life.



Evolved optical performance

Nikon's CFI60 optical system, highly evaluated for its unique concept of high NA combined with long working distance has further evolved to achieve the apex in long working distance, chromatic aberration correction, and light weight.

Easy Operation

Combination with digital camera

Detection of microscope information, including objective lens information, and motorized unit microscope operation are now possible using imaging software, for more efficient observation and image capture.

Observation Methods

Diverse observation / optical contrast methods

Combinations of a full range of accessories expand the observation methods available when using transmitted illumination, allowing adaptability to a greater diversity of samples.

All models enable brightfield, darkfield, differential interference, fluorescence, polarizing, and two-beam interferometry observation, while the LV100ND and LV100NDA also allow transmission-type differential interference, darkfield, polarizing, and phase contrast observation.



LV-N Series

Model features



LV150N



LV150NA



LV100ND



LV100NDA

Dedicated reflected illumination models

Combined reflected/transmitted illumination models

Microscope type

Manual type

Motorized type
(Nosepiece)

Manual type

Motorized type
(Nosepiece / light intensity / aperture stop / observation method selector)

Compatible observation methods

		Brightfield	Darkfield	DIC	Fluorescence	Polarizing	Two-beam Interferometry
LV150/ LV150NA	Episcopic	○	○	○	○	○	○
	Episcopic (LED)	○	○	○	—	△	—

* Use an objective lens appropriate to the observation method.
△ : only simple polarizing observation

		Brightfield	Darkfield	DIC	Fluorescence	Polarizing	Two-beam Interferometry	Phase-contrast
LV100ND/ LV100DA-U	Episcopic	○	○	○	○	○	○	—
	Episcopic (LED)	○	○	○	—	△	—	—
	Diascopic	○	○	○	—	○	—	○

* Use an objective lens appropriate to the observation method.
△ : only simple polarizing observation

Compatible stages

- LV-S32 3x2 stage (Stroke: 75 x 50 mm with glass plate)
*Can be fitted with LV-S32SPL ESD plate
- LV-S6 6x6 stage (Stroke: 150 x 150 mm)
*Can be fitted with LV-S6WH wafer holder / LV-S6PL ESD plate
- LV-SRP P revolving stage

- LV-S32 3x2 stage (Stroke: 75 x 50 mm with glass plate)
*Can be fitted with LV-S32SGH slide glass holder
- LV-S64 6x4 stage (Stroke: 150 x 100 mm with glass plate)
- LV-SRP P revolving stage
- NIU-CSRR2 Ni-U right handle rotatable ceramic stage (Stroke: 78 x 54 mm)
- C-CSR2S right handle stage (Stroke: 78 x 54 mm: Used with stage adapter LV-SAD)

Integration with Digital Sight cameras for microscopes

Digital Sight 10 or DS-Fi3 or Digital Sight 1000*

- Objective lens information detection** (when used with combination of Intelligent Nosepiece LV-NU5I and LV-INAD)

- Objective lens information detection and control**



Digital Sight 10 or DS-Fi3 or Digital Sight 1000*

- Objective lens information detection** (when used with combination of Intelligent Nosepiece LV-NU5I and LV-INAD)

- Information detection and control of objective lens, light intensity, aperture stop, and observation method (brightfield / darkfield / fluorescence)**



Evolved optical performance

Nikon's CFI60 optical systems are highly evaluated for their unique concept of high NA combined with a long working distance. These lenses have been developed further and evolved achieving the apex in long working distance specifications, correct chromatic aberration, and an optimized lens weight.

T Plan & TU Plan Fluor & TU Plan Apo Lenses Standard Plan objective lenses

Standard objective lenses

TU Plan Fluor series

EPI/BD 5x/10x/20x/50x/100x

Enable brightfield, darkfield, simple polarizing, sensitive polarizing, differential interference, and epi-fluorescence observations with just one lens. Achieves superior chromatic aberration performance with long working distance for all magnifications to adapt to any application.

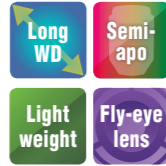

*Brightfield observation (EPI) objective lens

Model	Magnification	NA	Working Distance (mm)
TU Plan Fluor EPI (brightfield type)	5x	0.15	23.5
	10x	0.30	17.5
	20x	0.45	4.5
	50x	0.80	1.0
	100x	0.90	1.0
TU Plan Fluor BD (brightfield/darkfield type)	* 5x	0.15	18.0
	* 10x	0.30	15.0
	* 20x	0.45	4.5
	50x	0.80	1.0
	100x	0.90	1.0

* Uses fly-eye lens.

Low-magnification objective lenses

T Plan EPI

EPI 1x/2.5x

Both clear observation using a conventional analyzer/polarizer and operability-oriented observation without the need of an analyzer/polarizer are possible.



Model	Magnification	NA	Working Distance (mm)
T Plan EPI (brightfield type)	1x	0.03	3.8
	2.5x	0.075	6.5

Apochromatic objective lenses

TU Plan Apo series

EPI/BD 50x/100x/150x

By using phase Fresnel lenses, these objective lenses achieve significantly longer operating distances while maintaining the superior chromatic aberration performance of apochromatic lenses.



*Brightfield observation (EPI) objective lens

Model	Magnification	NA	Working Distance (mm)
TU Plan Apo EPI (brightfield type)	50x	0.8	2.0
	100x	0.9	2.0
	150x	0.9	1.5
TU Plan Apo BD (brightfield/darkfield type)	50x	0.8	2.0
	100x	0.9	2.0
	150x	0.9	1.5

TU Plan ELWD & T Plan SLWD Lenses Long working distance / Super-long working distance objective lenses

Long working distance objective lenses

TU Plan ELWD Series

EPI/BD 20x/50x/100x



With the phase Fresnel lenses, these objective lenses enable long working distances while offering higher level chromatic aberration correction than conventional objective lenses. This improves operability for samples with different heights.

*Brightfield observation (EPI) objective lens

Model	Magnification	NA	Working Distance (mm)
TU Plan EPI ELWD (brightfield type)	20x	0.4	19.0
	50x	0.6	11.0
	100x	0.8	4.5
TU Plan BD ELWD (brightfield/darkfield type)	20x	0.4	19.0
	50x	0.6	11.0
	100x	0.8	4.5

Super-long working distance objective lenses

T Plan EPI SLWD

EPI 10x/20x/50x/100x



Improving on chromatic aberration while prioritizing working distance, the T Plan SLWD Series achieve the best-in-class super-long working distance. The SLWD 10x (WD: 37 mm) lens enables use with a greater diversity of samples.

Model	Magnification	NA	Working Distance (mm)
T Plan EPI SLWD (brightfield type)	10x	0.2	37.0
	20x	0.3	30.0
	50x	0.4	22.0
	100x	0.6	10.0

Phase Fresnel

Color aberration correction
 Conventional lenses rely upon the refraction of light to form an image. As the strength of refraction varies according to color (wavelength), the image is formed starting with the light closest to the lens, in the order of blue, green, and red. In contrast, a phase Fresnel lens uses the diffraction of light to form an image starting with the light closest to the lens, this time, red, green, and blue, yielding a property opposite that of refraction. Combining these two lenses cancels out the color aberration of each and enables an image with little color aberration.

Realization of Long Working Distance
 Correction of color aberration, even with short distances between lenses, is possible with the use of phase Fresnel lenses. This enables longer working distance than that of conventional lenses.

Dark Field Illumination

Fly-eye lens

Through the use of fly-eye lenses, the CFI60-2 optical system offers bright darkfield illumination throughout the field of view with little unevenness, even for low-magnification lenses.

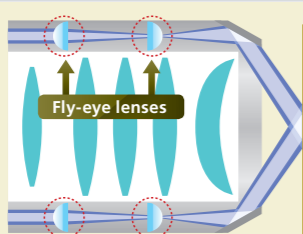

Fly-eye lenses adjust the diffusion angle of light so light strikes the focal surface without unevenness

Darkfield illumination system

As NA and WD improve, objective lenses increase in outside diameter. However, as the width of incident light is fixed, light intensity decreases with conventional illumination systems. The illumination system uses annular lenses or annular prisms to increase captured light and achieve bright darkfield illumination with no deterioration.

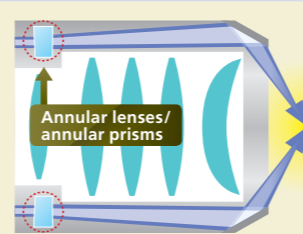

Annular lenses/prisms take in more light to increase brightness

Other lenses

Objective lenses with glass thickness correction features

CFI L Plan EPI CR 20x/50x/100x

Equipped with corrective features that enable high contrast observation of cells or patterns, these observation lenses are unaffected by the glass substrate.



Model	Magnification	NA	Working Distance (mm)
CFI L Plan EPI CR (brightfield type)	20x CR	0.45	10.90 - 10.00
	50x CR	0.70	3.90 - 3.00
	100x CRA	0.85	1.20 - 0.85
	100x CRB	0.85	1.30 - 0.95

Objective lenses for brightfield observation

CFI LE Plan EPI EPI 5x/10x/20x/50x/100x



LE Plan EPI

Model	Magnification	NA	Working Distance (mm)
LE Plan EPI (brightfield type)	5x	0.1	31.0
	10x	0.25	13.0
	20x	0.4	3.6
	50x	0.75	0.5
	100x	0.9	0.31

Easy Operation

Combination with digital camera

LV150N/LV100ND/LV150NA

Objective lens information detection and control

Information about the objective lens being used can be detected when combining the Intelligent Nosepiece LV-NU5I and the Nosepiece Adaptor LV-INAD. The information is automatically converted to appropriate calibration data when changing the magnification. In addition, the LV150NA allows switching of objective lenses via the imaging software.

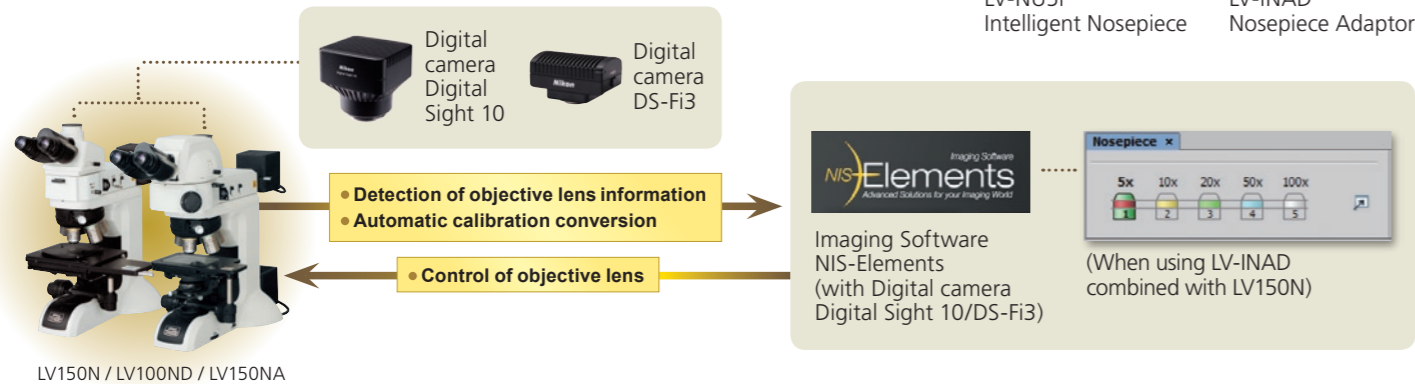

LV150N / LV100ND / LV150NA

LV100NDA

Microscope information detection and control

The LV100NDA allows detection of information and control of objective lenses, light intensity, aperture stop, and observation method (brightfield / darkfield / fluorescence) via the imaging software, enabling optimization of the conditions vital for image acquisition.

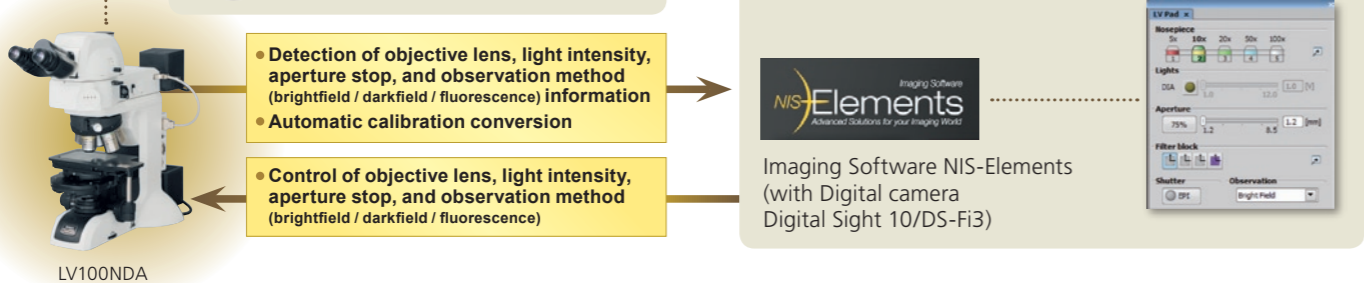

LV100NDA

Compatibility Chart of Information Detection and Control by Model

	LV150N/LV100ND (When using LV-NU5I and LV-INAD)	LV150NA	LV100NDA (When using LV-UEP12A Illuminator)
	Digital Sight 10/DS-Fi3 (+NIS-Elements)	Digital Sight 10/DS-Fi3 (+NIS-Elements)	Digital Sight 10/DS-Fi3 (+NIS-Elements)
Objective lens	○	◎	◎
Reflected illumination (ON/OFF, light intensity adjustment) <small>*When using LV-LH50PC</small>	—	—	◎
Transmitted illumination (ON/OFF, light intensity adjustment)	—	—	◎
Aperture stop	—	—	◎
Observation method selector (brightfield / darkfield / fluorescence)	—	—	◎

Note: With NIS-Elements L and F, functions above are not available. Use NIS-Elements D/Br/Ar.

Camera System

Digital camera system for microscopes "Digital Sight System"

Microscope Camera

Digital Sight 1000

Equipped with a 2 megapixel CMOS image sensor, it can capture full HD microscope images. By connecting a microscope to this camera and HDMI monitor, movies and images can be captured and saved onto a pre-inserted SD card in the camera.

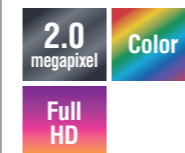

DS-Fi3

Three main features of the previous models, high-resolution, high sensitivity and low noise, and high-speed live display are offered in 1 camera.



Digital Sight 10

This high-resolution camera captures both color and monochromatic images at up to 6,000 x 3,984 pixels. This enables the wide range of images to be captured and then many of them to be stitched together making a single and large combined image.

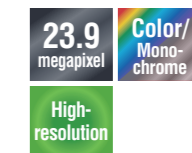

Frame Rate	30 fps (1920×1080)	30 fps (1440×1024)	66 fps (1920×1080)
Max Recordable Pixels	1920×1080	2880×2048	6000×3984

Imaging software NIS-Elements

Using a tablet PC



Simply installing NIS-Elements L on a tablet PC enables setting and control of Digital Sight 1000/DS-Fi3/Digital Sight 10 microscope cameras, live image display, and image acquisition.

Using a desktop PC

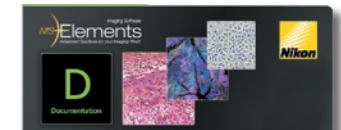

Wide variety of tools

NIS-Elements L enables the conducting of simple measurements on images, with input of lines and comments. These can also be written onto and saved with the image, and measurement data can be output.

Measurement function

- Line distance
- Area
- Circle
- Circle distance
- Pitch distance
- Angle

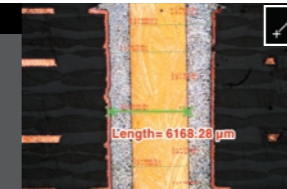

Annotate function

- Line
- Arrow
- Text
- Marker
- Polyline



Scene Mode

Ten camera setting patterns for optimal color reproduction and contrast for each microscope light source, observation method and type of sample, as well as custom settings, can be selected.

- Wafer/IC
- Circuit board
- Metal, Ceramic/Plastic
- Flat Panel Display

Image Stitching

Stitches together images acquired from multiple fields of view to create one image.

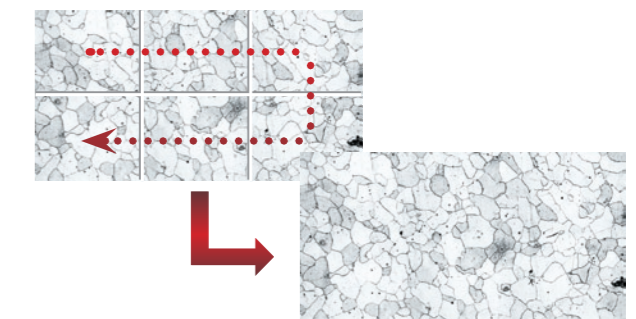

EDF (Extended Depth of Focus)

Create a single, all-in-focus image from images of differing focus.

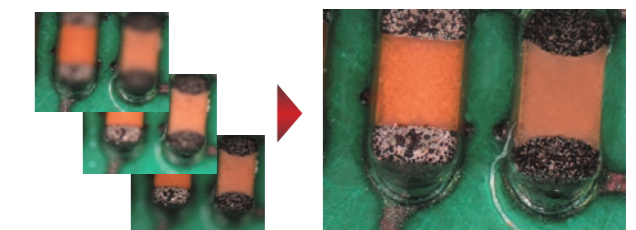

* See the "Digital Camera Digital Sight Series for Microscopes" brochure for details on Digital Sight features.

Observation Methods

Compatible with a wide range of observation / optical contrast methods: In reflected light mode -brightfield, darkfield, polarizing, differential interference, epi-fluorescence, and two-beam interferometry, and in Transmitted light mode- brightfield, darkfield, polarizing, differential interference, and phase contrast.

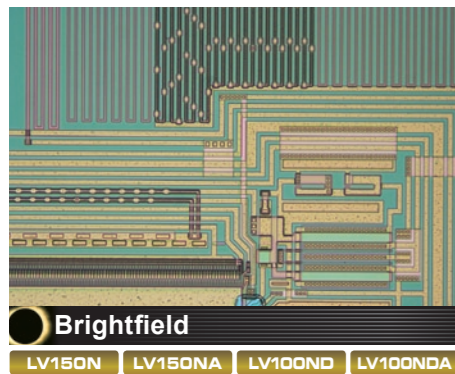

Brightfield

LV150N LV150NA LV100ND LV100NDA

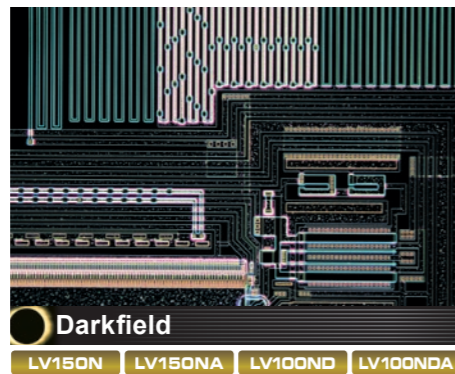

Darkfield

LV150N LV150NA LV100ND LV100NDA

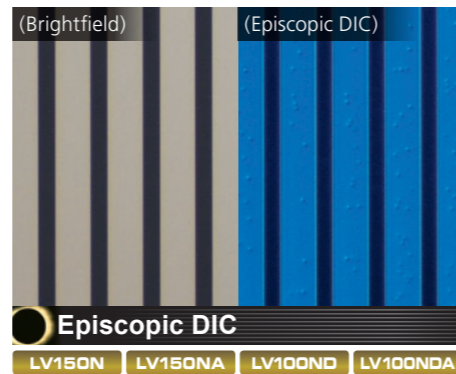

Episcopic DIC

LV150N LV150NA LV100ND LV100NDA

Semiconductors (IC wafers)

From its objective lenses to its illumination systems, the LV-N Series offers thorough measures against flare and provides bright, high-contrast images.

Semiconductors (IC wafers)

The use of Nikon's unique concepts in the objective lens darkfield illumination system enables bright darkfield observation and provides high-sensitivity detection of level differences and defects in samples.

Substrate

Standard-type and high-contrast-type DIC sliders are available to match samples. The LV-N Series is effective for applications such as observation of minute level differences in devices and precision molds.

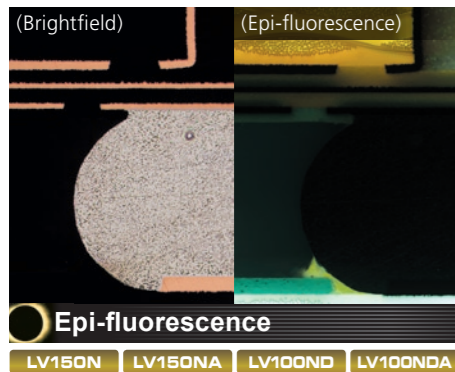

Epi-fluorescence

LV150N LV150NA LV100ND LV100NDA

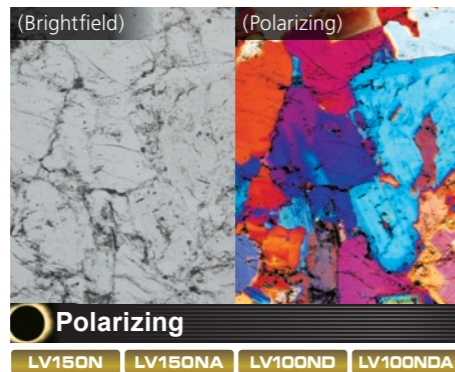

Polarizing

LV150N LV150NA LV100ND LV100NDA



Two-beam Interferometry

LV150N LV150NA LV100ND LV100NDA

Substrate (solder)

The LV-N Series demonstrates superiority in the observation of samples with fluorescent properties, such as organic ELs or mounted substrates.

Minerals

The LV-N Series is effective in the observation of samples with birefringent properties, such as liquid crystals or plastics/glass containing distortion.

Mica

Michelson (TI) and Mirau (DI) reflection-type two-beam interferometry is possible with the LV-N Series. When used with micrometer eyepieces, minute level differences can be detected and measured without contact with the sample.

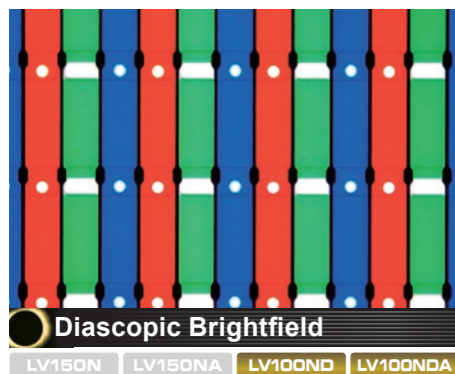

Diascopic Brightfield

LV150N LV150NA LV100ND LV100NDA

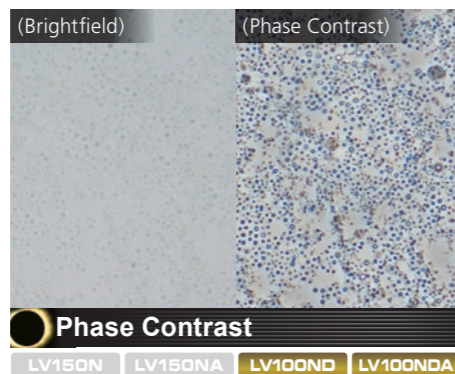

Phase Contrast

LV150N LV150NA LV100ND LV100NDA



Diascopic DIC

LV150N LV150NA LV100ND LV100NDA

LCD (color filter)

The LV-N Series is effective in the observation of samples with transparency, such as optical components, FPDs, and slide glass samples. When used in conjunction with the C-SP Simple Polarizer and analyzers, transmitted simple polarized observation is possible.

Emulsion

Colorless, transparent samples can be made visible through bright/dark contrast and the use of diffraction and interference, two properties of light.

Nanoparticle (silver)

Colorless, transparent samples can be observed in three dimensions by using polarization to create interference between two beams of light.

Specifications

	LV150N	LV150NA
Base unit	Maximum sample height: 38 mm (when used with LVNU5A U5A nosepiece and LV-S32 3x2 stage / LV-S64 6x4 stage) *73 mm when used with one column riser 12V50W internal power source for dimmer, coarse and fine adjustment knobs Left: coarse and fine adjustment / Right: fine adjustment, 40 mm stroke Coarse adjustment: 14 mm/turn (with torque adjustment, refocusing mechanism) Fine adjustment: 0.1 mm/turn (1 μm/graduation) Stage mounting hole intervals: 70 x 94 (fixed by 4-M4 screw)	
Nosepieces	C-N6 ESD Sextuple Nosepiece ESD LV-NU5 Universal Quintuple Nosepiece ESD LV-NBD5 BD Quintuple Nosepiece ESD LV-NU5I Intelligent Universal Quintuple Nosepiece ESD	LV-NU5A Motorized Universal Quintuple Nosepiece ESD LV-NU5AC Motorized Universal Quintuple Nosepiece ESD
Episcopic Illuminator	LV-UEPI-N LV-LH50PC 12V50W Precentered Lamphouse, LV-LL LED Lamphouse Bright/darkfield switch and linked aperture stop (centerable), field diaphragm (centerable) Accepts ø 25 mm filter (NCB11, ND16, ND4), polarizer/analyzer, λ plate, excitation light balancer; equipped with noise terminator LV-UEPI2 LV-LH50PC 12V50W Precentered Lamphouse, LV-LL LED Lamphouse HG precentered fiber illuminator: C-HGFIE (with light adjustment) *option Fluorescence LED Light Source D-LED1 (with light adjustment (PC controllable) *LV150N only) Bright/darkfield switch and linked aperture stop (centerable), field diaphragm (centerable), automated optical element switching feature matched to brightfield, darkfield, and epi-fluorescence switch Accepts ø 25 mm filter (NCB11, ND16, ND4), polarizer/analyzer, λ plate, excitation light balancer; equipped with noise terminator	
Eyepiece tubes	LV-T13 trinocular eyepiece tube ESD (Erected image, FOV: 22/25) LV-TT2 TT2 tilting trinocular eyepiece tube (Erected image, FOV: 22/25) C-TB binocular tube (Inverted image, FOV: 22) P-TB Binocular Tube (Inverted image, FOV: 22) P-TT2 Trinocular Tube (Inverted image, FOV: 22)	
Stages	LV-S32 3x2 stage (Stroke: 75 x 50 mm with glass plate) ESD compatible LV-S64 6x4 stage (Stroke: 150 x 100 mm with glass plate) ESD compatible LV-S6 6x6 stage (Stroke: 150 x 150 mm) ESD compatible	
Eyepieces	CFI eyepiece series	
Objective lenses	Industrial Microscope CFI ₆₀ -2/CFI ₆₀ optical system Objective lens series: Combinations in accordance with the observation method	
ESD performance	1,000 to 10V, within 0.2 sec. (excluding certain accessories)	
Power consumption	1.2 A / 75 W	
Weight	Approx. 8.6 kg	Approx. 8.7 kg

	LV100ND	LV100NDA
Base unit	Maximum sample height: 38 mm (when used with LV-NU5 U5 nosepiece and LV-S32 3x2 stage / LV-S64 6x4 stage) 12V50W internal power source for dimmer, coarse and fine adjustment knobs Left: coarse and fine adjustment / Right: fine adjustment, 40 mm stroke Coarse adjustment: 14 mm/turn (with torque adjustment, refocusing mechanism) Fine adjustment: 0.1 mm/turn (1 μm/graduation)	Maximum sample height: 33 mm (when used with LVNU5AI U5AI nosepiece and LV-S32 3x2 stage / LV-S64 6x4 stage) 12V50W internal power source for dimmer, coarse and fine adjustment knobs Left: coarse and fine adjustment / Right: fine adjustment, 40 mm stroke Coarse adjustment: 14 mm/turn (with torque adjustment, refocusing mechanism) Fine adjustment: 0.1 mm/turn (1 μm/graduation)
Nosepieces	C-N6 ESD Sextuple Nosepiece ESD, LV-NU5 Universal Quintuple Nosepiece ESD LV-NBD5 BD Quintuple Nosepiece ESD, LV-NU5I Intelligent Universal Quintuple Nosepiece ESD D-ND6 Sextuple DIC Nosepiece	LV-NU5AI Motorized Universal Quintuple Nosepiece (High-durability motorized 5-hole universal nosepiece)
Episcopic Illuminators	LV-UEPI-N LV-LH50PC 12V50W Precentered Lamphouse, LV-LL LED Lamphouse Bright/darkfield switch and linked aperture stop (centerable), field diaphragm (centerable), accepts ø 25 mm filter (NCB11, ND16, ND4), polarizer/analyzer; equipped with noise terminator LV-UEPI2 LV-LH50PC 12V50W Precentered Lamphouse, LV-LL LED Lamphouse HG precentered fiber illuminator: C-HGFIE (with light adjustment) *option Fluorescence LED Light Source D-LED1 (with light adjustment (PC controllable) *LV100ND only) Bright/darkfield switch and linked aperture stop (centerable), field diaphragm (centerable), automated optical element switching feature matched to brightfield, darkfield, and epi-fluorescence switch Accepts ø 25 mm filter (NCB11, ND16, ND4), polarizer/analyzer, λ plate, excitation light balancer; equipped with noise terminator	
Diascopic Illuminator	LV-LH50PC 12V50W Precentered Lamphouse (Fly Eye optical system) Internal aperture, field diaphragm, filter (ND8, NCB11); transmitted/reflected selector switch; 12V100W also available (option)	
Eyepiece tubes	LV-T13 trinocular eyepiece tube ESD (Erected image, FOV: 22/25), LV-TT2 TT2 tilting trinocular eyepiece tube (Erected image, FOV: 22/25), P-TB Binocular Tube (Inverted image, FOV: 22), P-TT2 Trinocular Tube (Inverted image, FOV: 22)	
Stages	LV-S32 3x2 stage (Stroke: 75 x 50 mm with glass plate) / LV-S32SGH slide glass holder LV-S64 6x4 stage (Stroke: 150 x 100 mm with glass plate), LV-SRP P revolving stage NIU-CSRR2 Ni-U right handle rotatable ceramic stage (Stroke: 78 x 54 mm), C-CSR2S right handle stage (Stroke: 78 x 54 mm: Used with stage adapter LV-SAD)	
Condensers	LWD achromat condenser (brightfield), LV-CUD U condenser dry (phase contrast, diascopic DIC, darkfield), Achromat 2x-100x slide condenser (brightfield), DF dry condenser (darkfield), and others	
Eyepieces	CFI eyepiece series	
Objective lenses	Industrial Microscope CFI ₆₀ -2/CFI ₆₀ optical system Objective lens series: Combinations in accordance with the observation method	
ESD performance	1,000 to 10V, within 0.2 sec. (excluding certain accessories)	1.2 A / 90 W
Power consumption	1.2 A / 75 W	Approx. 10 kg
Weight	Approx. 9.5 kg	

Lens Specifications

Type	Model	Magnification	Product Code No.	NA	Working Distance (mm)
Brightfield	T Plan EPI	1x	MUE12010	0.03	3.8
	Plan (Achromat)	2.5x	MUE12030	0.075	6.5
	TU Plan Fluor EPI	5x	MUE12050	0.15	23.5
	Universal Plan Fluor (Semi-apochromat)	10x	MUE12100	0.3	17.5
		20x	MUE12200	0.45	4.5
		50x	MUE12500	0.8	1.0
		100x	MUE12900	0.9	1.0
	TU Plan Apo EPI	50x	MUC11500	0.8	2.0
	Universal Plan Apo (Apochromat)	100x	MUC11900	0.9	2.0
		150x	MUC11150	0.9	1.5
Polarizing	TU Plan Fluor EPI P	5x	MUE13050	0.15	23.5
	Polarizing Universal Plan Fluor (Semi-apochromat)	10x	MUE13100	0.3	17.5
		20x	MUE13200	0.45	4.5
		50x	MUE13500	0.8	1.0
		100x	MUE13900	0.9	1.0
Brightfield Long Working Distance	TU Plan EPI ELWD	20x	MUE21200	0.4	19.0
	Long Working Distance Universal Plan (Semi-apochromat)	50x	MUE21500	0.6	11.0
		100x	MUE21900	0.8	4.5
Brightfield Super-long Working Distance	T Plan EPI SLWD	10x	MUE31100	0.2	37.0
	Super-long Working Distance Plan (Semi-apochromat)	20x	MUE31200	0.3	30.0
		50x	MUE31500	0.4	22.0
		100x	MUE31900	0.6	10.0
Brightfield/Darkfield	TU Plan Fluor BD	5x	MUE42050	0.15	18.0
	Universal Plan Fluor (Semi-apochromat)	10x	MUE42100	0.3	15.0
		20x	MUE42200	0.45	4.5
		50x	MUE42500	0.8	1.0
		100x	MUE42900	0.9	1.0
	TU Plan Apo BD	50x	MUC41500	0.8	2.0
	Universal Plan Apo (Apochromat)	100x	MUC41900	0.9	2.0
	150x	MUC41150	0.9	1.5	
Brightfield/Darkfield Long Working Distance	TU Plan BD ELWD	20x	MUE61200	0.4	19.0
	Long Working Distance Universal Plan (Semi-apochromat)	50x	MUE61500	0.6	11.0
		100x	MUE61900	0.8	4.5

• Phase Fresnel lens (diffraction optical element) type • A circular polarizing plate and depolarizer are built into T Plan EPI 1x/2.5x. (Circular polarizing plate can be attached/detached.)

Type	Model	Magnification	Product Code No.	NA	Working Distance (mm)
Brightfield With Correction Mechanism	L Plan EPI CR	20x	MUE35200	0.45	10.9 - 10.0
	For Inspecting LCDs Plan	50x	MUE35500	0.7	3.9 - 3.0
		100x	MUE35900	0.85	1.2 - 0.85
		100x	MUE35910	0.85	1.3 - 0.95
Brightfield	L Plan EPI Plan (Achromat)	40x	MUE00400	0.65	1.0
Brightfield	LU Plan Apo EPI	100x	MUC00090	0.95	0.4
	Universal Plan Apo (Apochromat)	150x	MUC10151	0.95	0.3
Brightfield/Darkfield	LU Plan Apo BD	100x	MUC40900	0.9	0.51
	Universal Plan Apo (Apochromat)	150x	MUC50151	0.9	0.42
Brightfield	LE Plan EPI (Achromat)	5x	MUD00050	0.1	31.0
		10x	MUD00100	0.25	13.0
		20x	MUD00200	0.4	3.6
		50x	MUD00500	0.75	0.5
		100x	MUD00900	0.9	0.31

Dimensions

LV150N / LV150NA

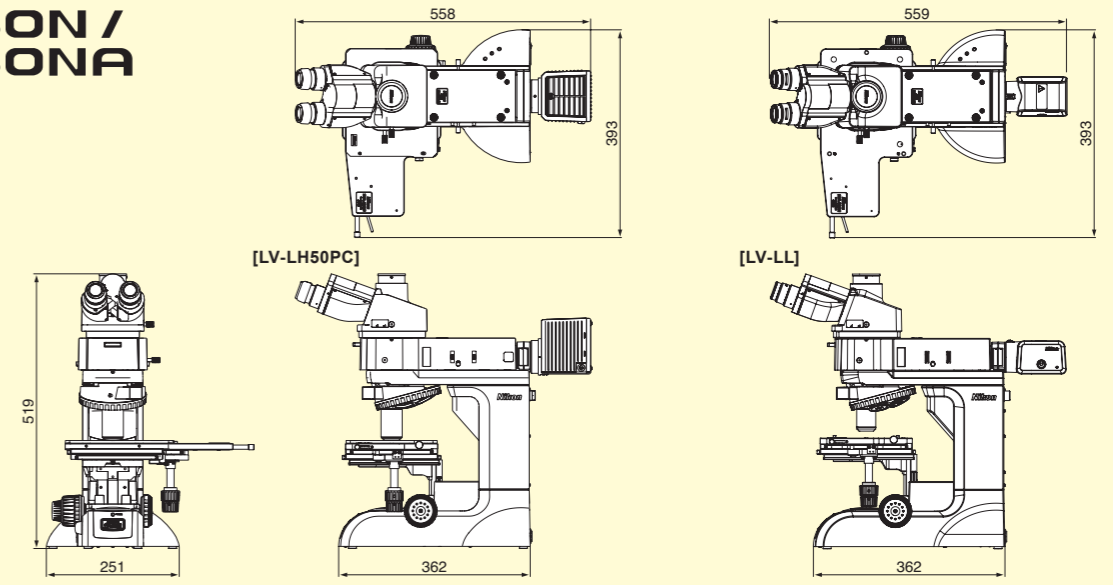

LV100ND

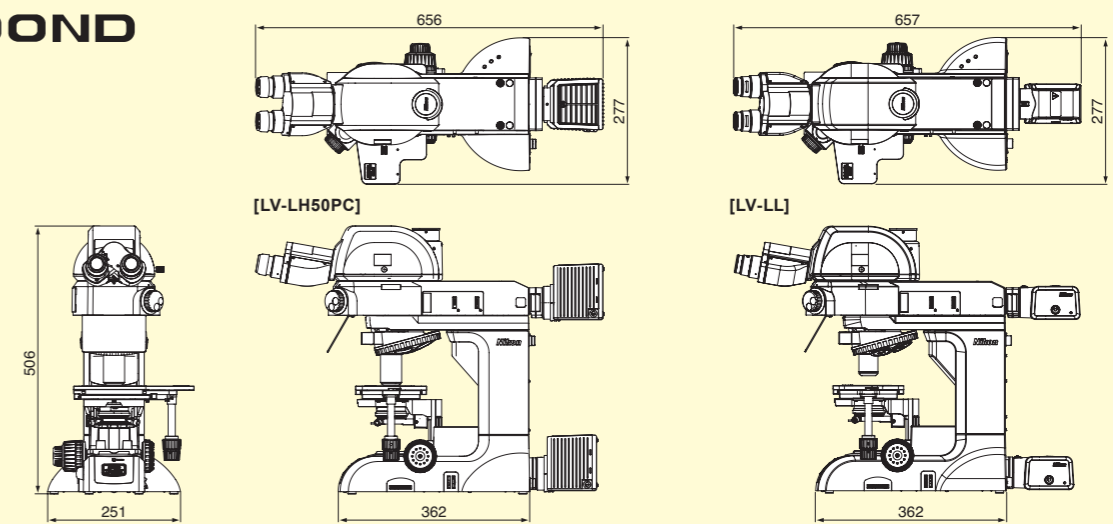

LV100NDA

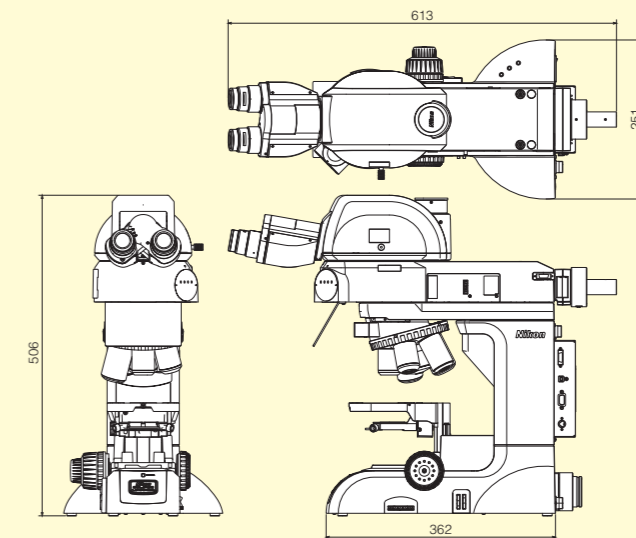

Specifications and equipment are subject to change without any notice or obligation on the part of the manufacturer. June 2023 ©2012-2023 NIKON CORPORATION

N.B. Export of the products* in this brochure is controlled under the Japanese Foreign Exchange and Foreign Trade Law. Appropriate export procedures shall be required in case of export from Japan.

*Products: Hardware and its technical information (including software)

Company names and product names appearing in this brochure are their registered trademarks or trademarks.



WARNING

TO ENSURE CORRECT USAGE, READ THE CORRESPONDING MANUALS CAREFULLY BEFORE USING THE EQUIPMENT.



NIKON CORPORATION

1-5-20, Nishioji, Shinagawa-ku, Tokyo 140-8601, Japan
phone: +81-3-6743-5742 fax: +81-3-6410-7252
<https://industry.nikon.com/>

ISO 14001 Certified
for NIKON CORPORATION

ISO 9001 Certified
for NIKON CORPORATION
Industrial Metrology Business Unit

NIKON METROLOGY EUROPE NV

Interleuvenlaan 86 B-3001 Leuven, Belgium
phone: +32-16-74-01-00 fax: +32-16-74-01-03
E-mail: Sales.Europe.NM@nikon.com
<https://industry.nikon.com/en-gb/>

NIKON METROLOGY UK LTD.

UNITED KINGDOM phone: +44-1332-811-349 fax: +44-1332-639-881
E-mail: Sales.UK.NM@nikon.com

NIKON METROLOGY SARL

FRANCE phone: +33-1-60-86-09-76 fax: +33-1-60-86-57-35
E-mail: Sales.France.NM@nikon.com

NIKON METROLOGY GMBH

GERMANY phone: +49-211-45-44-69-51
E-mail: Sales.Germany.NM@nikon.com

NIKON INSTRUMENTS S.p.A.

ITALY phone: +39-055-300-96-01 fax: +39-055-30-09-93

NIKON METROLOGY, INC.

12701 Grand River Road, Brighton, MI 48116 U.S.A.
phone: +1-810-220-4360 fax: +1-810-220-4300
E-mail: Sales.NM-US@nikon.com
<https://industry.nikon.com/en-us/>

NIKON METROLOGY - MÉXICO

E-mail: Sales.NM-MX@nikon.com

NIKON PRECISION (SHANGHAI) CO., LTD.

CHINA (Shanghai branch) phone: +86-21-6841-2050 fax: +86-21-6841-2060
(Beijing branch) phone: +86-10-5831-2028 fax: +86-10-5831-2026
(Guangzhou branch) phone: +86-20-3882-0551 fax: +86-20-3882-0580

NIKON INSTRUMENTS KOREA CO., LTD.

KOREA phone: +82-2-6288-1900 fax: +82-2-555-4415

NIKON SINGAPORE PTE. LTD.

SINGAPORE phone: +65-6559-3651 fax: +65-6559-3668
E-mail: NSG.Industrial-sales@nikon.com

PT. NIKON INDONESIA

INDONESIA phone: +62-213-873-5005 fax: +62-213-873-5006

E-mail: PTN.Instruments@nikon.com

NIKON SALES (THAILAND) CO., LTD.

THAILAND phone: +66-2633-5100 fax: 66-2633-5191