



Microscopes for Flat Panel Display and Large Scale Integration Inspection

ECLIPSE L300N/L300ND L200N/L200ND

Microscopes for Flat Panel Display
and Large Scale Integration Inspection



ECLIPSE



L300N
For ø300 mm wafer/
Episcopic optical contrast



L300ND
For 17-inch FPD/
Episcopic and Diascopic optical contrast



L200N
For ø200 mm wafer/
Episcopic optical contrast



L200ND
For ø200 mm wafer/
Episcopic and Diascopic optical contrast

Enhanced observation performance and operation

Epi-fluorescence observation widens inspection range—including 365 nm UV excitation

*L300N/L300ND/L200ND only

- Highly beneficial when inspecting semiconductor resist residues and organic electroluminescence displays.
- Various observation methods such as brightfield, darkfield, simple polarizing, and DIC are possible on all models.
- With the L300ND/L200ND, diascopic illumination capability adds the illumination through transparent substrates.

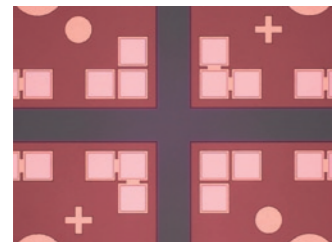

Brightfield observation
of wafer pattern

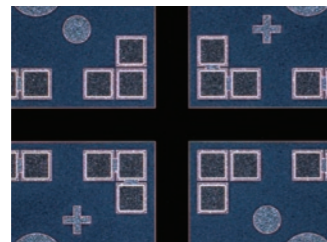

Darkfield observation

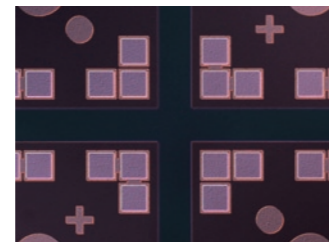

DIC observation



Epi-fluorescence observation of
organic substance on wafer

Front operation with easy access

- Minimizes fatigue during lengthy observations, maintaining a safer operator distance from the sample

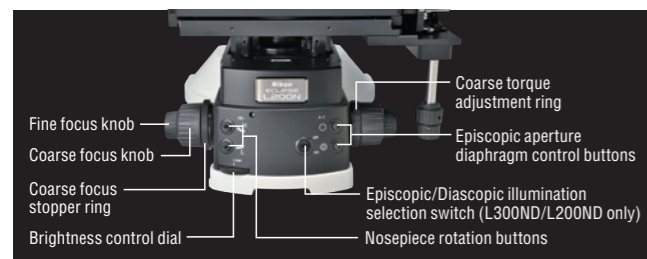

Target for easier focusing

- Insert a focusing target in the optical path to easily focus on low-contrast samples, such as bare wafers.

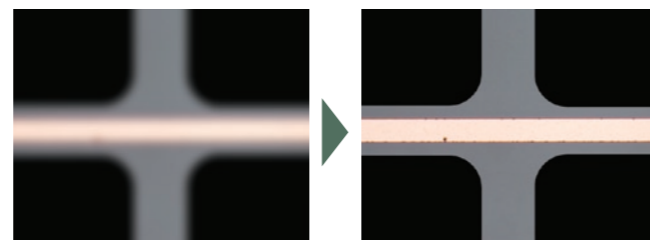

Stronger safeguard against contamination

- Antistatic coatings applied to the body, stage, eyepiece tube and other various controls
- Prevents damage to samples and contributes to higher yields

Observation at optimum eyepoint level

- Ultra-wide 25-mm field of view and eyepiece angle adjustment between 0° and 30°
- Operators can adjust eyepoint level to ensure a comfortable viewing position



Fixed-position X-Y fine movement control

- Allows for stage movements and focusing to be carried out with ease



Illumination

LED

Compact LED illuminators are power saving and achieve long life.



LV-LL LED Lamphouse

Intensilight

- Motorized mercury precentered fiber illuminator for epi-fluorescence observation, with variable light intensity and shutter control, provide excellent flexibility. Lamp centering and focus adjustment are not necessary.

Filter blocks

For epi-fluorescence observation

- EPI-FL UV-2A
- EPI-FL V-2A
- EPI-FL BV-2A



*Only one cube is attachable.

Accessories

Nikon's CFI60 optical systems are highly evaluated for their unique concept of high NA combined with a long working distance. These lenses have been developed further and evolved achieving the apex in long working distance specifications, correct chromatic aberration, and an optimized lens weight.

Objective lenses

Standard objective lenses

TU Plan Fluor Series

EPI/BD 5x/10x/20x/50x/100x



Enable brightfield, darkfield, simple polarizing, sensitive polarizing, differential interference, and epi-fluorescence observations with just one lens. Achieves superior chromatic aberration performance with long working distance for all magnifications to adapt to any application.



*Brightfield observation (EPI) objective lens

Model	Magnification	NA	Working Distance (mm)
TU Plan Fluor EPI (brightfield type)	5x	0.15	23.5
	10x	0.30	17.5
	20x	0.45	4.5
	50x	0.80	1.0
TU Plan Fluor BD (brightfield/ darkfield type)	100x	0.90	1.0
	5x	0.15	18.0
	10x	0.30	15.0
	20x	0.45	4.5
	50x	0.80	1.0
	100x	0.90	1.0

Long working distance objective lenses

TU Plan ELWD Series

EPI/BD 20x/50x/100x



With the phase Fresnel lenses, these objective lenses enable long working distances while offering higher level chromatic aberration correction than conventional objective lenses. This improves operability for samples with different heights.



*Brightfield observation (EPI) objective lens

Model	Magnification	NA	Working Distance (mm)
TU Plan EPI ELWD (brightfield type)	20x	0.4	19.0
	50x	0.6	11.0
	100x	0.8	4.5
TU Plan BD ELWD (brightfield/ darkfield type)	20x	0.4	19.0
	50x	0.6	11.0
	100x	0.8	4.5

Low-magnification objective lenses

T Plan EPI

EPI 1x/2.5x



Model	Magnification	NA	Working Distance (mm)
T Plan EPI (brightfield type)	1x	0.03	3.8
	2.5x	0.075	6.5

Apochromatic objective lenses

TU Plan Apo Series

EPI/BD 50x/100x/150x



By using phase Fresnel lenses, these objective lenses achieve significantly longer operating distances while maintaining the superior chromatic aberration performance of apochromatic lenses.



*Brightfield observation (EPI) objective lens

Model	Magnification	NA	Working Distance (mm)
TU Plan Apo EPI (brightfield type)	50x	0.8	2.0
	100x	0.9	2.0
	150x	0.9	1.5
TU Plan Apo BD (brightfield/ darkfield type)	50x	0.8	2.0
	100x	0.9	2.0
	150x	0.9	1.5

Other lenses

Lenses with correction mechanism

CFI L Plan EPI CR Series

EPI 20x/50x/100x



Model	Magnification	NA	Working Distance (mm)	Glass Thickness Correction Range (mm)
CFI L Plan EPI CR	20x	0.45	10.9-10.0	0-1.2
CFI L Plan EPI CR	50x	0.7	3.9-3.0	0-1.2
CFI L Plan EPI CRA	100x	0.85	1.2-0.85	0-0.7
CFI L Plan EPI CRB	100x	0.85	1.3-0.95	0.6-1.3

Microscope camera

Digital Sight 1000

Equipped with a 2 megapixel CMOS image sensor, it can capture full HD microscope images. By connecting a microscope to this camera and HDMI monitor, movies and images can be captured and saved onto a pre-inserted SD card in the camera.

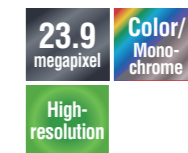
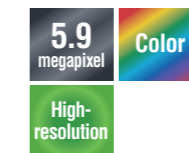
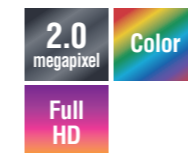

Frame Rate	30 fps (1920x1080)	30 fps (1440x1024)	66 fps (1920x1080)
Max Recordable Pixels	1920x1080	2880x2048	6000x3984

Imaging software NIS-Elements

Using a tablet PC



Simply installing NIS-Elements L on a tablet PC enables setting and control of Digital Sight 1000/DS-Fi3/Digital Sight 10 microscope cameras, live image display, and image acquisition.

Using a desktop PC

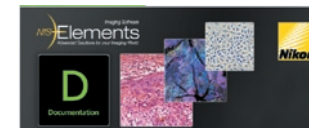

A wide variety of tools

NIS-Elements L enables the conducting of simple measurements on images, with input of lines and comments. These can also be written onto and saved with the image, and measurement data can be output.

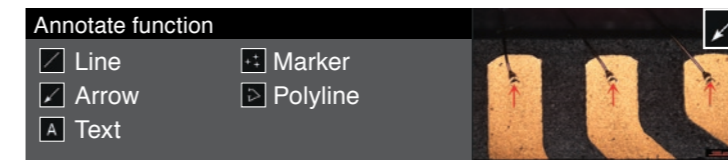
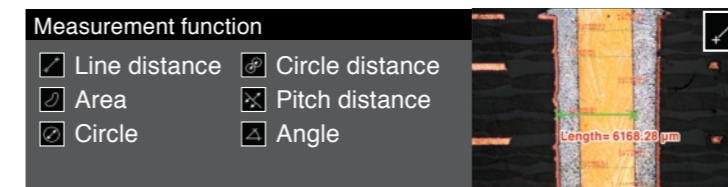
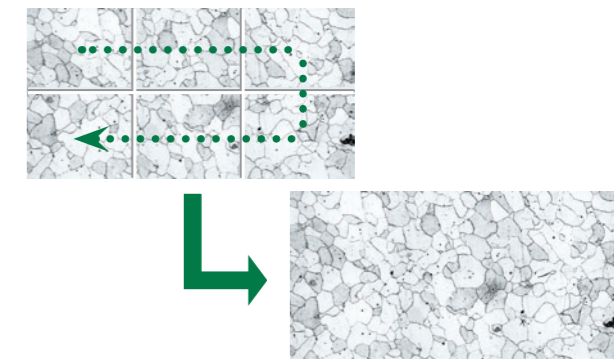

Image Stitching

Stitch together images acquired from multiple fields of view to create one image.



EDF (Extended Depth of Focus)

Create a single, all-in-focus image from images of differing focus.

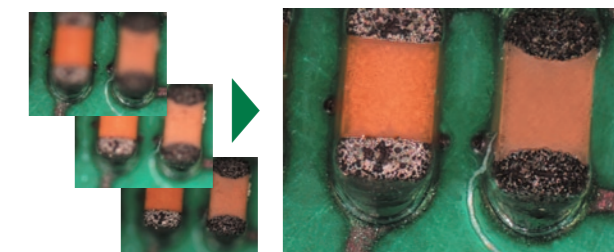

Scene Mode

Ten camera setting patterns for optimal color reproduction and contrast for each microscope light source, observation method and type of sample, as well as custom settings, can be selected.

- Wafer/IC
- Metal, Ceramic/Plastic
- Circuit board
- Flat Panel Display

* See the "Digital Camera Digital Sight Series for Microscopes" catalog for details on Digital Sight features.

Wafer loader NWL200

Combined with the NWL200 wafer loader, the ECLIPSE L200N meets requirements for wafer inspections.

Support for ultra-thin 100 µm wafers

- NWL200 series provides levels of safety and reliability that meet all requirements for inspection of the latest wafers.

Improved operability and high throughput

- Setting conditions, such as sampling and inspection patterns, and checking the operating status and content of errors can easily be done with the large LCD panel
- Comprehensive file management functions for carriers and samples are useful for automating inspections
- Exceptionally fast elevator, and the loading and unloading of wafers with complete precision by the multi-arm system all contribute to an efficient wafer transfer and exchange



Dimensional diagram (Unit: mm)

ECLIPSE L300N/L300ND

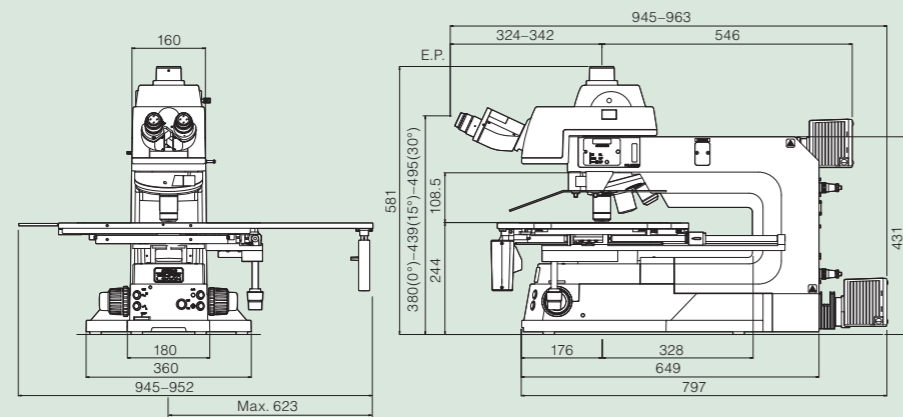

ECLIPSE L200N/L200ND

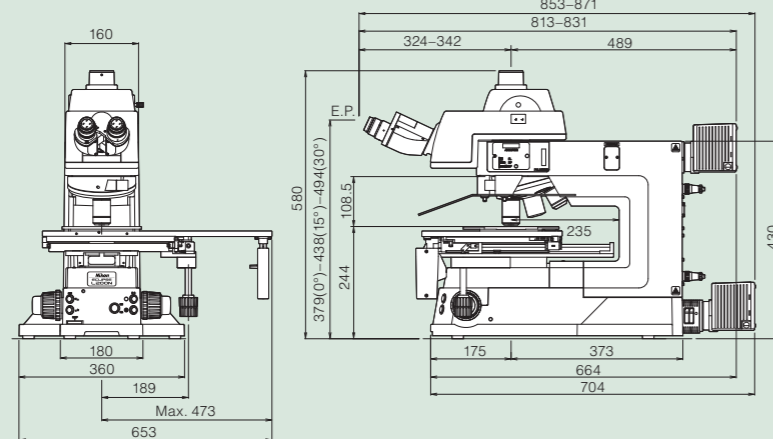

System diagram

ECLIPSE L300N/L300ND

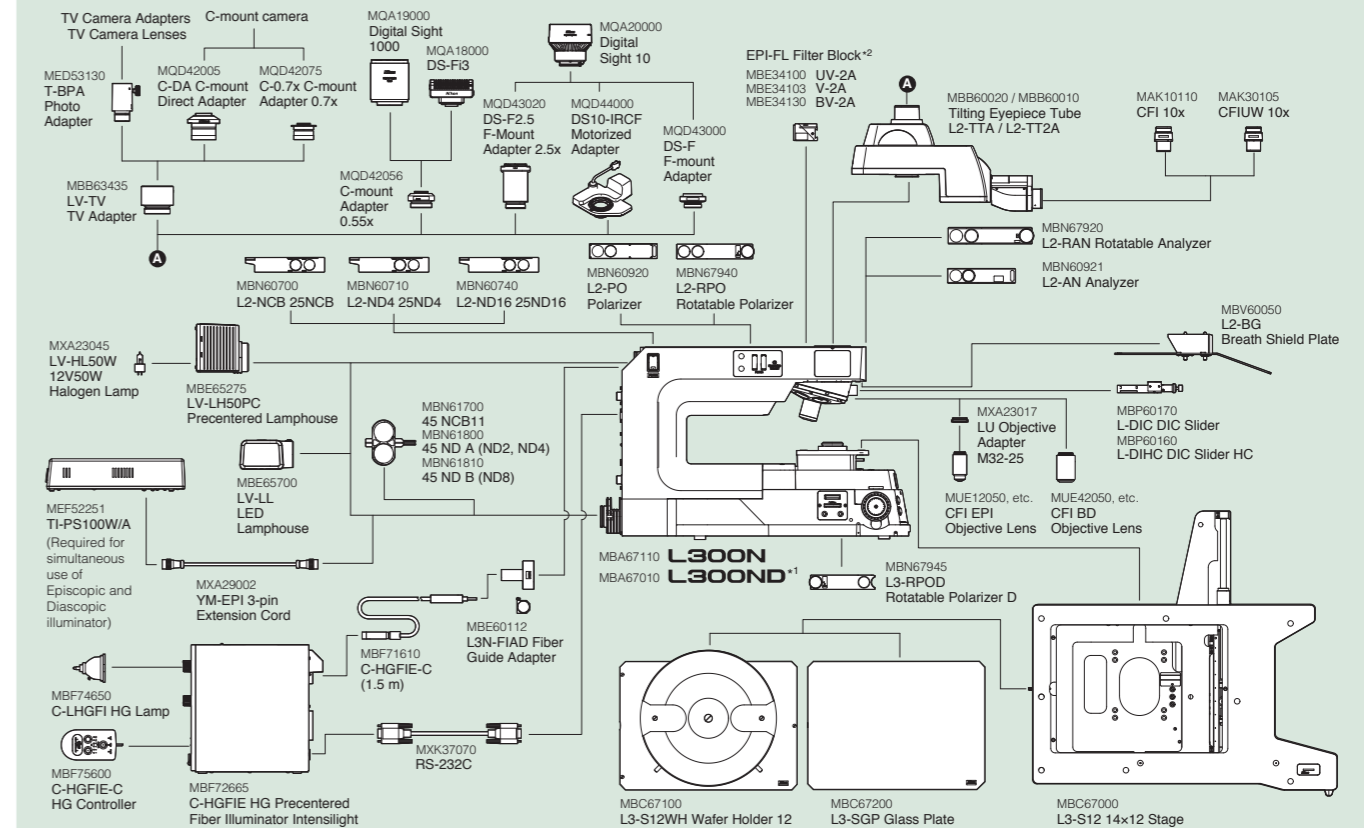

ECLIPSE L200N/L200ND

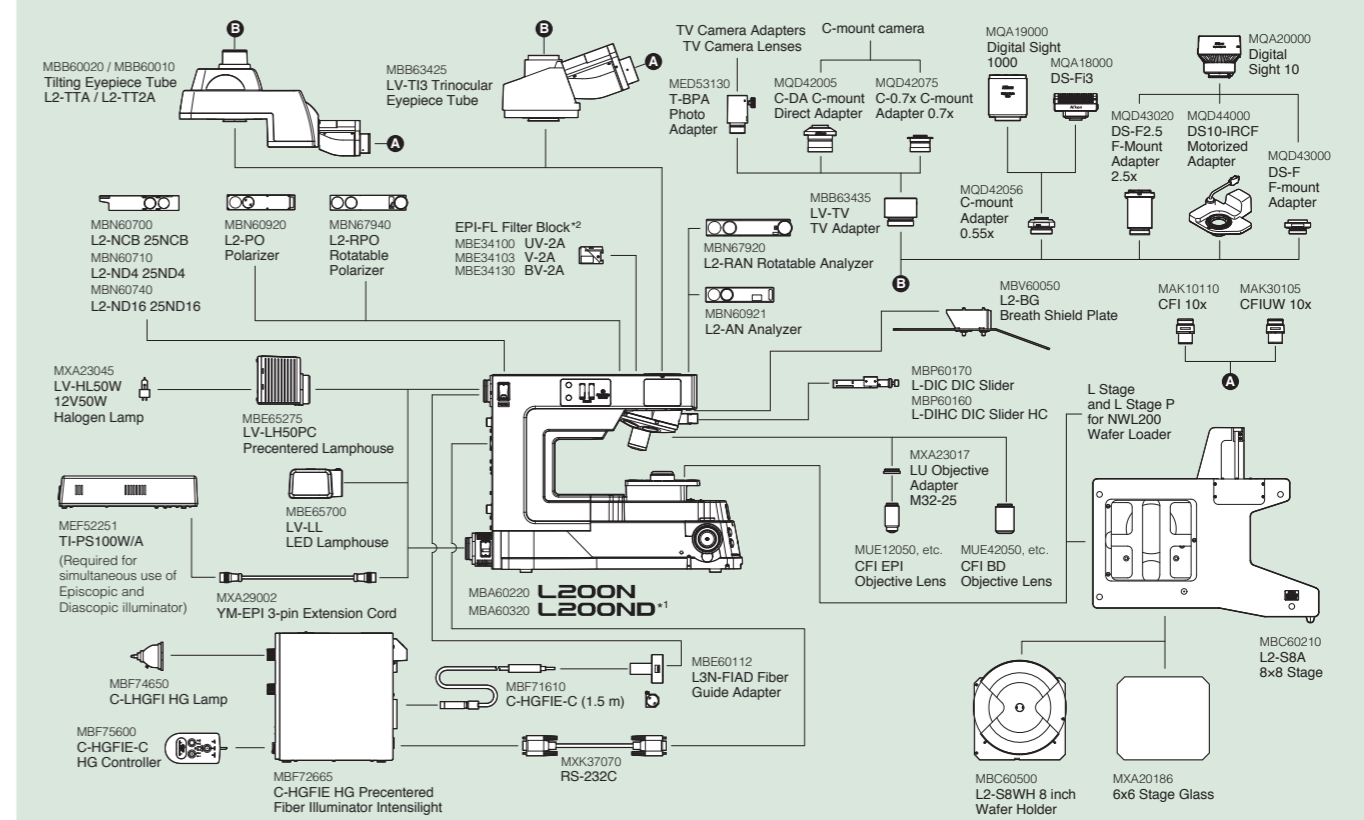

*1 Diascopic illumination available only for L300ND and L200ND
*2 Epi-fluorescence observation available only for L300ND/L300N/L200ND

Specifications

		ECLIPSE L300N	ECLIPSE L200N	ECLIPSE L300ND	ECLIPSE L200ND
Illumination type		Episcopic		Episcopic/Diascopic	
Main body		Power sources for motorized control built in Motorized control for nosepiece, Light intensity control, Aperture diaphragm control			
Nosepiece		Motorized universal sextuple nosepiece			
	Centering Function	Yes	—	Yes	—
	EPI/DIA changeover	—	—	Yes	
Focusing mechanism	Cross travel	29 mm			
	Coarse	12.7 mm per rotation (torque adjustable, refocusing mechanism provided)			
	Fine	0.1 mm per rotation (in 1 μm increments)			
Episcopic illuminator		12V-50W halogen lamp light source built in, LV-LL LED Lamphouse Motorized aperture diaphragm (centerable), Fixed field diaphragm (with focus target) Pinhole slider (optional), Four ø25 mm filters (NCB11, ND16, ND4), Polarizer and Analyzer can be mounted Observation methods: Brightfield, Darkfield, Simple polarizing, DIC, Epi-fluorescence* (*L300N/L300ND/L200ND only)			
Diascopic illuminator		—		12V-50W halogen lamp light source built in, LV-LL LED Lamphouse Aperture diaphragm built in LWD condenser built in	
Interface		USB x 1, RS232C (for Intensilight) x 1			
Eyepiece tubes		L2-TT2A Ultra-widefield erect-image tilting trinocular eyepiece tube (tilt angle: 0-30 °) FOV: 22/25; Beam split ratio 100:0/20:80 L2-TTA Ultra-widefield erect-image tilting trinocular eyepiece tube (tilt angle: 0-30 °) FOV: 22/25; Beam split ratio 100:0/0:100 LV-TI3 Trinocular eyepiece tube (erect image) FOV: 22/25; Beam split ratio 100:0/0:100			
Eyepieces		CFI eyepiece lens series			
Objective lenses		CFI ₆₀ -2/CFI ₆₀ system			
Stages		L3-S12 14 x 12 stage	L2-S8A 8 x 8 stage	L3-S12 14 x 12 stage	L2-S8A 8 x 8 stage
	Stroke	354 x 302 mm	205 x 205 mm	354 x 302 mm	205 x 205 mm
	Diascopic observation range	354 x 268 mm	150 x 150 mm	354 x 268 mm	150 x 150 mm
		Coarse/Fine-movement changeover possible Fixed-position X-Y fine-movement controls			
Antistatic mechanism		1000-10 V, within 0.2 sec			
Power consumption		1.2 A/90 W			
Weight (approx.)	Body only	38 kg	31 kg	40 kg	31 kg
	With L2-S8A 8 x 8 stage and L2-TTA eyepiece tube	—	45 kg	—	44 kg
	With L3-S12 14 x 12 stage and L2-TTA eyepiece tube	57 kg	—	59 kg	—

Specifications and equipment are subject to change without any notice or obligation on the part of the manufacturer. September 2024 ©2010-2024 NIKON CORPORATION

N.B. Export of the products* in this brochure is controlled under the Japanese Foreign Exchange and Foreign Trade Law. Appropriate export procedures shall be required in case of export from Japan.

*Products: Hardware and its technical information (including software)

WARNING	TO ENSURE CORRECT USAGE, READ THE CORRESPONDING MANUALS CAREFULLY BEFORE USING THE EQUIPMENT.
----------------	---



NIKON CORPORATION

1-5-20, Nishi-ku, Shinagawa-ku, Tokyo 140-8601, Japan
phone: +81-3-6743-5742 fax: +81-3-6410-7252
<https://industry.nikon.com/>

ISO 14001 Certified
for NIKON CORPORATION

ISO 9001 Certified
for NIKON CORPORATION
Industrial Solutions Business Unit

NIKON METROLOGY EUROPE NV

Interleuvenlaan 86 B-3001 Leuven, Belgium
phone: +32-16-74-01-00 fax: +32-16-74-01-03
E-mail: Sales.Europe.NM@nikon.com
<https://industry.nikon.com/en-gb/>

NIKON METROLOGY UK LTD.

UNITED KINGDOM phone: +44-1332-811-349 fax: +44-1332-639-881
E-mail: Sales.UK.NM@nikon.com

NIKON METROLOGY SARL

FRANCE phone: +33-1-60-86-09-76 fax: +33-1-60-86-57-35
E-mail: Sales.France.NM@nikon.com

NIKON METROLOGY GMBH

GERMANY phone: +49-211-45-44-69-51
E-mail: Sales.Germany.NM@nikon.com

NIKON INSTRUMENTS S.p.A.

ITALY phone: +39-055-300-96-01 fax: +39-055-30-09-93

NIKON METROLOGY, INC.

12701 Grand River Road, Brighton, MI 48116 U.S.A.
phone: +1-810-220-4360 fax: +1-810-220-4300
E-mail: Sales.NM-US@nikon.com
<https://industry.nikon.com/en-us/>

NIKON METROLOGY - MÉXICO

E-mail: Sales.NM-MX@nikon.com

NIKON PRECISION (SHANGHAI) CO., LTD.

CHINA (Shanghai branch) phone: +86-21-6841-2050 fax: +86-21-6841-2060
(Beijing branch) phone: +86-10-5831-2028 fax: +86-10-5831-2026
(Guangzhou branch) phone: +86-20-3882-0551 fax: +86-20-3882-0580

NIKON INSTRUMENTS KOREA CO., LTD.

KOREA phone: +82-2-6288-1900 fax: +82-2-555-4415

NIKON SINGAPORE PTE. LTD.

SINGAPORE phone: +65-6559-3651 fax: +65-6559-3668
E-mail: NSG.Industrial-sales@nikon.com

PT. NIKON INDONESIA

INDONESIA phone: +62-213-873-5005 fax: +62-213-873-5006
E-mail: PTN.Instruments@nikon.com

NIKON SALES (THAILAND) CO., LTD.

THAILAND phone: +66-2633-5100 fax: +66-2633-5191